

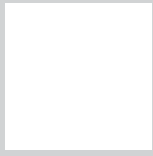

# Extrugasa

Extrusión, Lacado, Anodizado y Mecanizado de Perfiles de Aluminio.



Serie Muebles y Mamparas

[www.extrugasa.com](http://www.extrugasa.com)

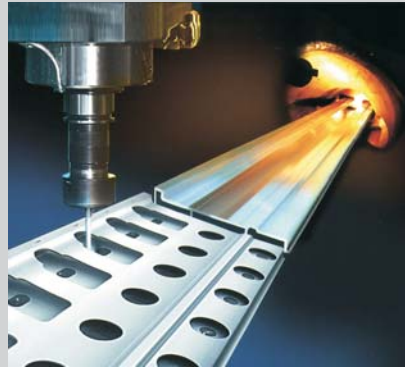

10





Furniture division

División de muebles

1500

20 x 20 mm tube

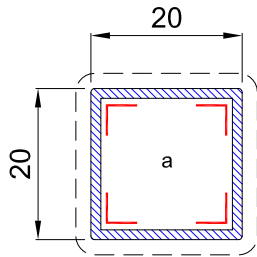

Tubo de 20 x 20 mm

Ref.: 1500

Peso (kg/m): 0.267

Momentos de inercia

Perímetro (mm): 151

Ix (cm4): 0,57

Iy (cm4): 0,57

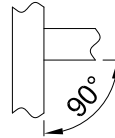

Accesorios

Montaje

a: A497424B  
(3711)

Maquina / Manual

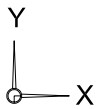

2157

20 x 30 mm furniture division one exits

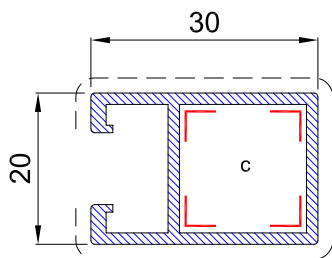

División muebles una salida de 20 x 30 mm

Ref.: 2157

Peso (kg/m): 0.432

Momentos de inercia

Perímetro (mm): 208

Ix (cm4): 0,97

Iy (cm4): 1,55

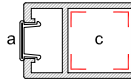

Accesorios

Montaje

a: A497400B  
(3441)

Manual

b: A497423B (opcional)  
(3911)

Manual

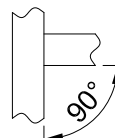

c: A497424B  
(3711)

Maquina / Manual

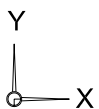

# SERIE MUEBLES

División de muebles

Furniture division

2364

40 x 20 mm furniture division two exists

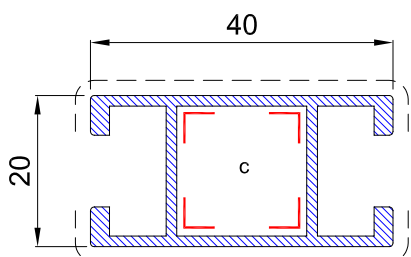

División muebles dos salidas 40 x 20 mm

Ref.: 2364

Peso (kg/m): 0.543

Momentos de inercia

Perímetro (mm): 261

Ix (cm4): 1,26

Iy (cm4): 3,25

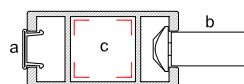

Accesorios

Montaje

a: A497400B  
(3441)

Manual

b: A497423B (opcional)  
(3911)

Manual

c: A497424B  
(3711)

Maquina / Manual

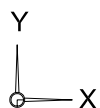
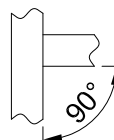

2339

80 x 20 mm furniture division two exists

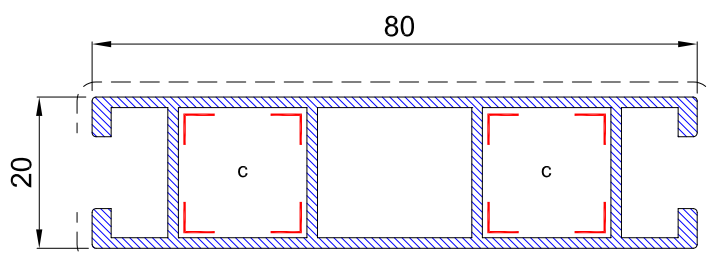

División muebles dos salidas 80 x 20 mm

Ref.: 2339

Peso (kg/m): 0.975

Momentos de inercia

Perímetro (mm): 484

Ix (cm4): 2,35

Iy (cm4): 22,37



Accesorios

Montaje

a: A497400B  
(3441)

Manual

b: A497423B (opcional)  
(3911)

Manual

c: A497424B  
(3711)

Maquina / Manual

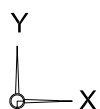
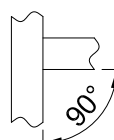

2365

40 x 30 mm furniture division three exits

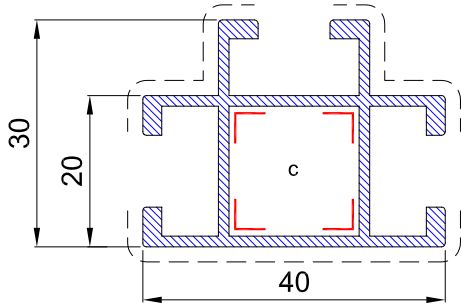

División muebles tres salidas 40 x 30 mm

Ref.: 2365

Peso (kg/m): 0.670

Momentos de inercia

Perímetro (mm): 315

Ix (cm4): 2,34

Iy (cm4): 3,58

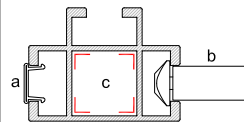

Accesorios

Montaje

a: A497400B  
(3441)

Manual

b: A497423B (opcional)  
(3911)

Manual

c: A497424B  
(3711)

Maquina / Manual

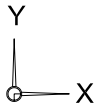
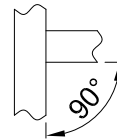

# SERIE MUEBLES

## Esquineros muebles

## Furniture corners

2368

29.6 mm furniture corner cm - 30

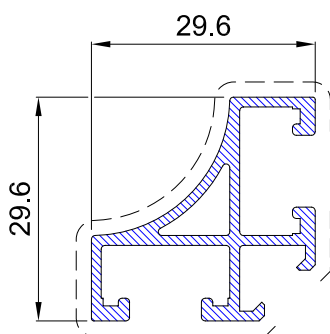

Esquinero muebles cm - 30 de 29.6 mm

Ref.: 2368

Peso (kg/m): 0.475

Momentos de inercia

Perímetro (mm): 232

Ix (cm4): 1,33

Iy (cm4): 1,33

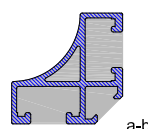

Accesorios

Montaje

a: Tapeta cm-30



Manual

b: Nudo cm-30

Manual

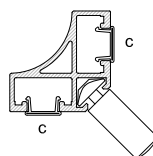

c: A497400B  
(3441)

Manual

d: A497423B (opcional)  
(3911)

Manual

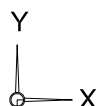

2367

29.6 mm furniture corner t - 30

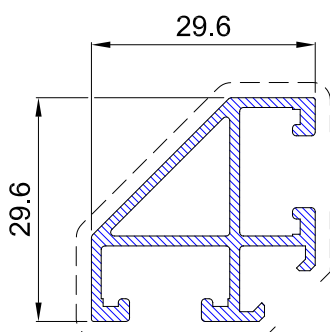

Esquinero muebles t - 30 de 29.6 mm

Ref.: 2367

Peso (kg/m): 0.494

Momentos de inercia

Perímetro (mm): 253

Ix (cm4): 1,47

Iy (cm4): 1,47

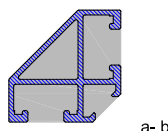

Accesorios

Montaje

a: Tapeta t-30



Manual

b: Nudo t-30

Manual

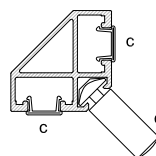

c: A497400B  
(3441)

Manual

d: A497423B (opcional)  
(3911)

Manual

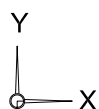

Furniture corners

Esquineros muebles

2272

30 x 30 mm furniture corner mc - 30

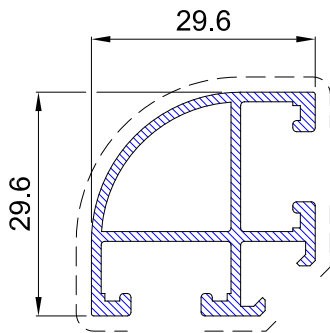

Esquinero muebles mc - 30 de 30 x 30 mm

Ref.: 2272

Peso (kg/m):	0.516	Momentos de inercia	
Perímetro (mm):	267	Ix (cm4): 1,63	Iy (cm4): 1,63

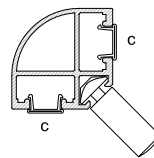
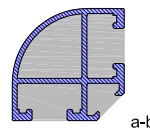

Accesorios	Montaje
a: A497413B (3811) 	Manual
b: A497401B (3501)	Manual
c: A497400B (3441)	Manual
d: A497423B (opcional) (3911)	Manual

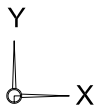

2366

40 mm furniture corner mc - 40

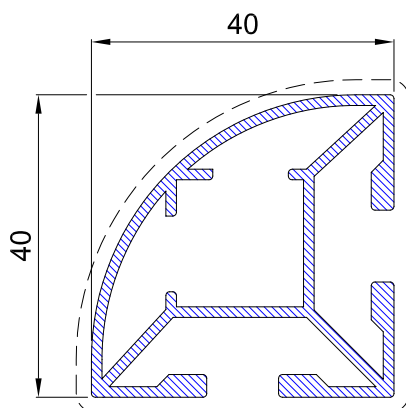

Esquinero muebles mc - 40 de 40 mm

Ref.: 2366

Peso (kg/m):	0.894	Momentos de inercia	
Perímetro (mm):	421	Ix (cm4): 5,65	Iy (cm4): 5,65

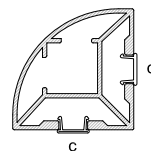
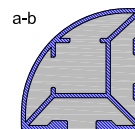

Accesorios	Montaje
a: A497536B (815) 	Manual
b: A497089B (3505)	Manual
c: A497400B (3441)	Manual

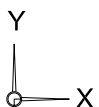

# SERIE MUEBLES

Perfil octogonal

Octogonal profile

2338

48 mm octogonal profile t - 8

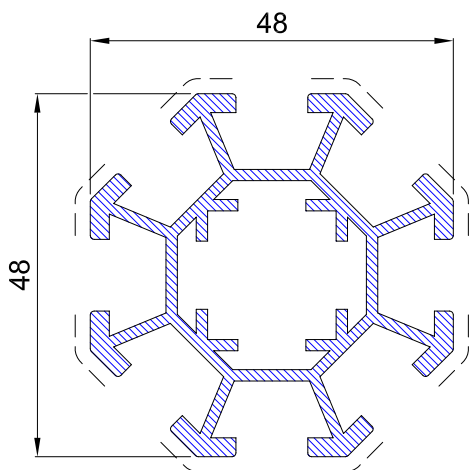

Perfil octogonal t - 8 de 48 mm

Ref.: 2338

Peso (kg/m): 1.253

Momentos de inercia

Perímetro (mm): 525

Ix (cm4): 8,64

Iy (cm4): 8,64

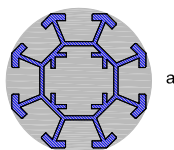

Accesorios

Montaje

a: A497537B  
(3818)



Manual

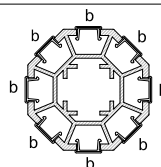

b: A497400B  
(3441)

Manual

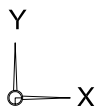



Tensile

Tensores

3058

Furniture male tensile

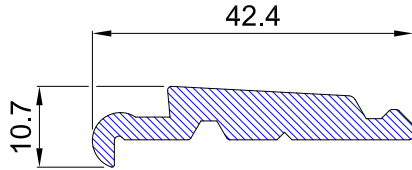

Tensor macho para muebles

Ref.: 3058

Peso (kg/m): 0.583

Momentos de inercia

Perímetro (mm): 108

Ix (cm4): 5,65

Iy (cm4): 5,65

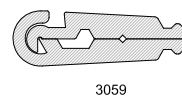

Accesorios

Montaje

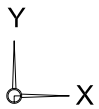

3059

Furniture male tensile

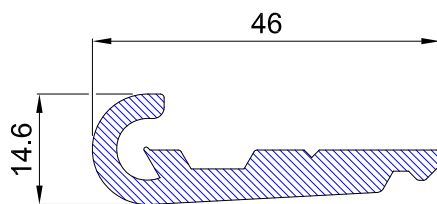

Tensor hembra para muebles

Ref.: 3059

Peso (kg/m): 0.724

Momentos de inercia

Perímetro (mm): 137

Ix (cm4): 2,34

Iy (cm4): 3,58

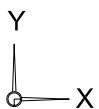
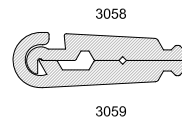

# SERIE MUEBLES

Hoja de mueble

Furniture sash

2995

10.6 x 12 mm beading for furniture sheet

Junquillo para hoja mueble de 10.6 x 12 mm

Ref.: 2995

Peso (kg/m): 0.113

Momentos de inercia

Perímetro (mm): 70

Ix (cm4): 0,07

Iy (cm4): 0,06

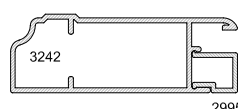
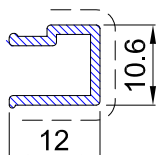

Accesorios

Montaje

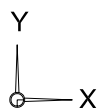

3242

60 x 19.8 mm furniture sheet

Hoja de mueble de 60 x 19.8 mm

Ref.: 3242

Momentos de inercia: X: 1,3983,8507  
Y: 6,6003,4994

Peso (kg/m): 0.551

Momentos de inercia

Perímetro (mm): 314

Ix (cm4): 1,40

Iy (cm4): 6,60

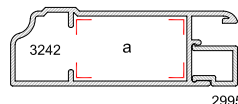
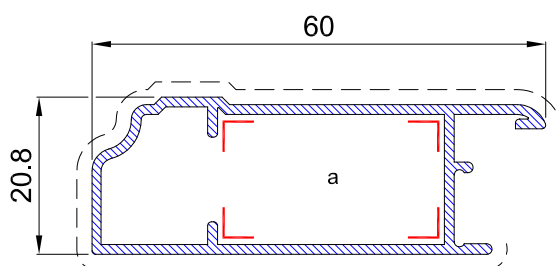

Accesorios

Montaje

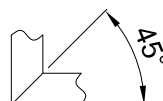

a: A497857B  
(00-1731-50)

Manual

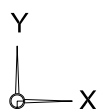

Cornice

Cornisa

3241

50.4 x 31.4 mm lower cornice

Cornisa inferior de 50.4 x 31.4 mm

Ref.: 3241

Peso (kg/m): 0.424

Momentos de inercia

Perímetro (mm): 227

Ix (cm4): 1,47

Iy (cm4): 5,80

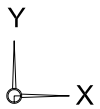
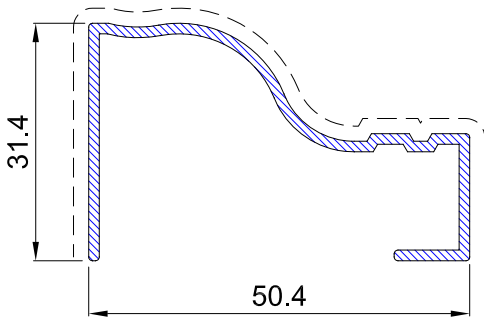

3249

81.3 x 56.7 mm upper cornice

Cornisa superior de 81.3 x 56.7 mm

Ref.: 3249

Peso (kg/m): 0.532

Momentos de inercia

Perímetro (mm): 283

Ix (cm4): 8,17

Iy (cm4): 11,21

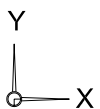
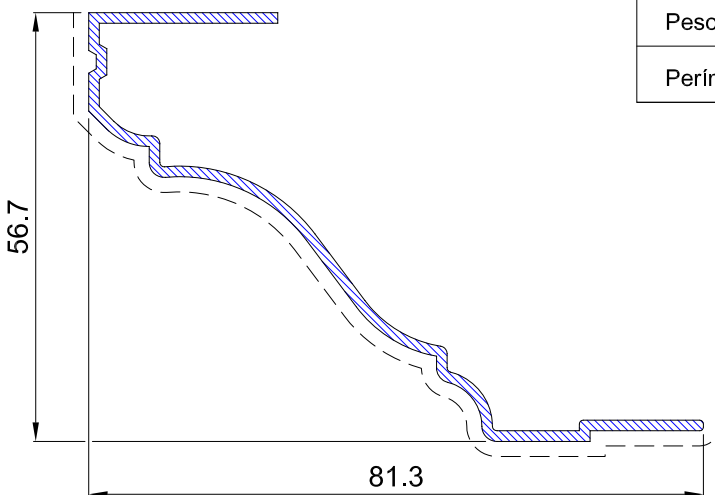

# SERIE MUEBLES

Cornisa

Cornice

3230

150 x 80 mm cornice

Cornisa de 150 x 80 mm

Ref.: 3230

Peso (kg/m): 1.496

Momentos de inercia

Perímetro (mm): 617

Ix (cm4): 31,15

Iy (cm4): 155,07

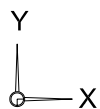
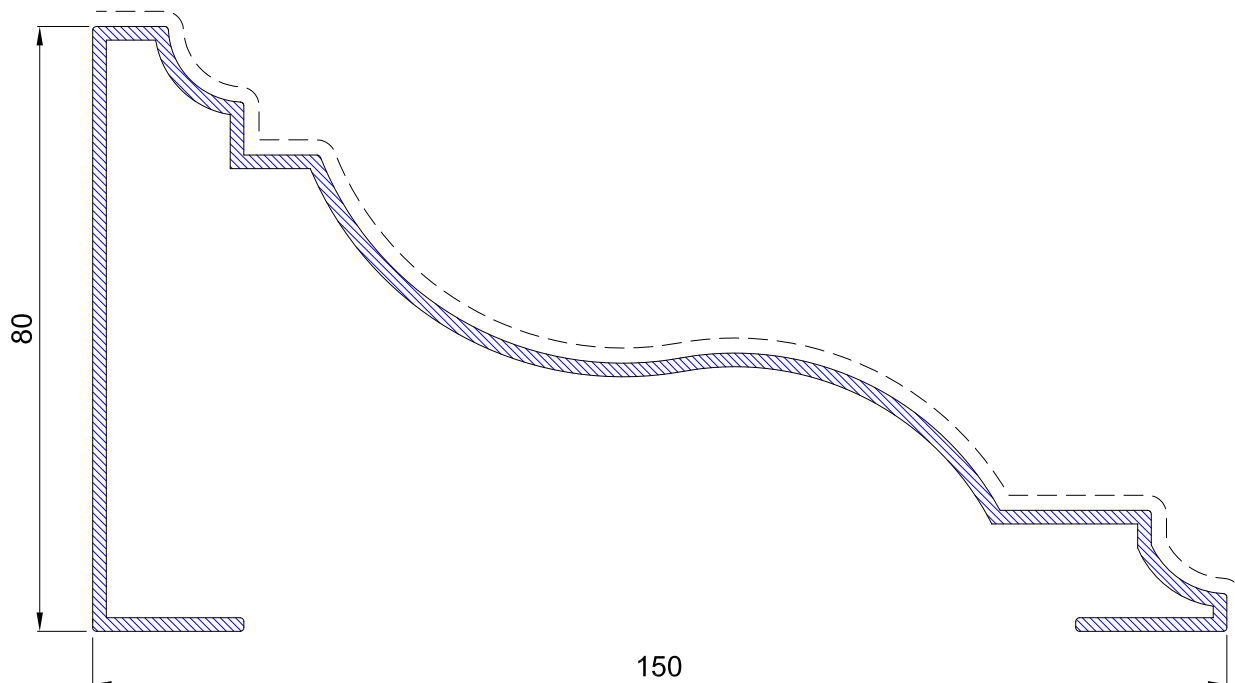

Several

Varios

1140

200 x 6.2 mm aluminium plate waves

Duela de 200 x 6.2 mm

Ref.: 1140

Peso (kg/m): 0.907

Momentos de inercia

Perímetro (mm): 474

Ix (cm4): 31,15

Iy (cm4): 155,07

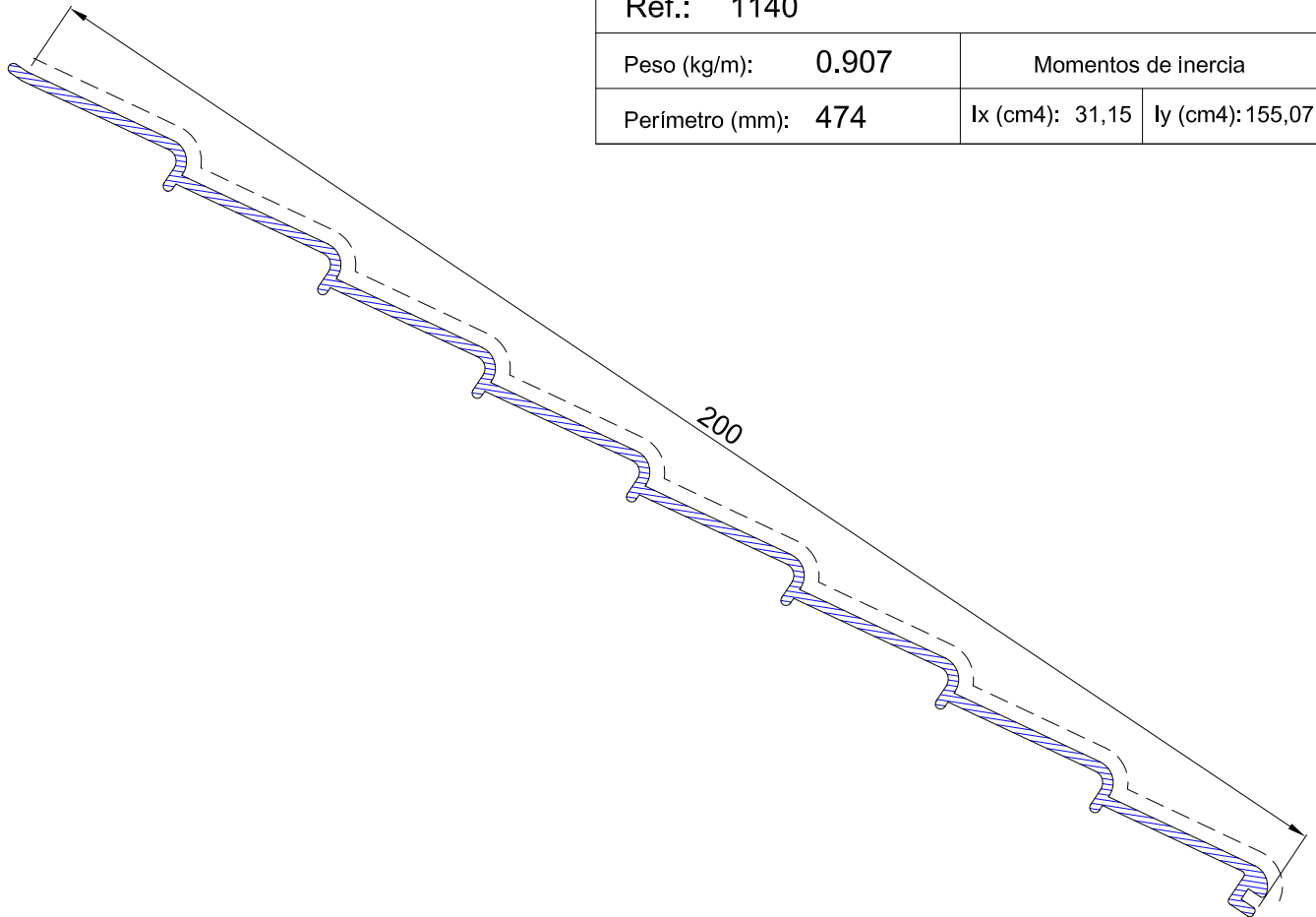

1165

30 x 16 mm hanger bar

Barra para perchas de 30 x 16 mm

Ref.: 1165

Peso (kg/m): 0.265

Momentos de inercia

Perímetro (mm): 152

Ix (cm4): 0,35

Iy (cm4): 0,90

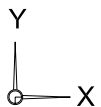
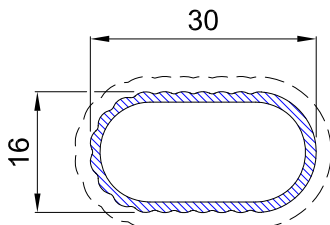

# SERIE MUEBLES

Varios

Several

3004

Shelf profile

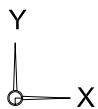
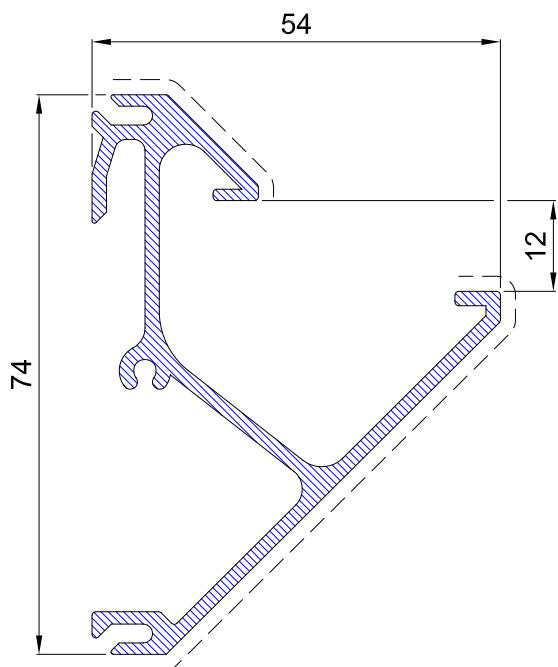

Perfil estantería

Ref.: 3004

Peso (kg/m): 1.115

Momentos de inercia

Perímetro (mm): 394

Ix (cm4): 20,27

Iy (cm4): 8,46

2917

50.4 x 22 mm picture profile

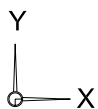
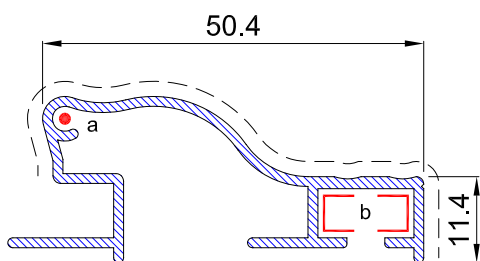

Perfil cuadros de 50.4 x 22 mm

Ref.: 2917

Peso (kg/m): 0.459

Momentos de inercia

Perímetro (mm): 263

Ix (cm4): 0,77

Iy (cm4): 5,07

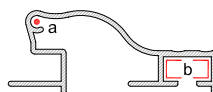

Accesorios

Montaje

a: A497665B

Manual

b: A497664B

Manual

Several

Varios

3834

Lateral sash

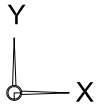
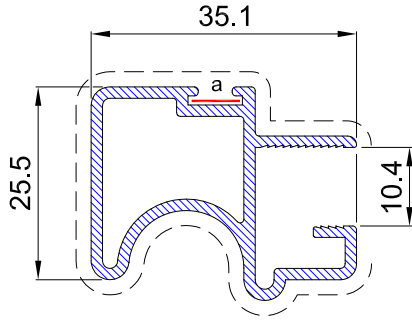

Hoja lateral

Ref.: 3834

Peso (kg/m): 0.562

Momentos de inercia

Perímetro (mm): 279

Ix (cm4): 1,53

Iy (cm4): 2,40

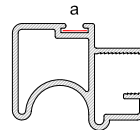

Accesorios

Montaje

a: Polipelo 6.9 x 8



Maquina / Manual

3835

Lateral sash

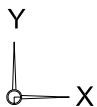
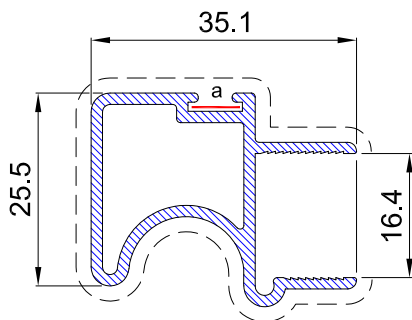

Hoja lateral

Ref.: 3835

Peso (kg/m): 0.521

Momentos de inercia

Perímetro (mm): 261

Ix (cm4): 1,45

Iy (cm4): 1,94

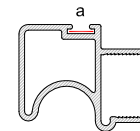

Accesorios

Montaje

a: Polipelo 6.9 x 8



Maquina / Manual



# SERIE MUEBLES

## Marcos inferiores

## Lower frames

3836

Lower frame

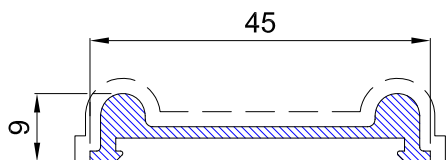

Marco inferior

Ref.: 3836

Peso (kg/m): 0.348

Momentos de inercia

Perímetro (mm): 122

Ix (cm4): 0,05

Iy (cm4): 3,18

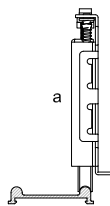

Accesorios

Montaje

a: A497458B  
(GA-256)

Manual

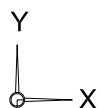

12792

Lower frame

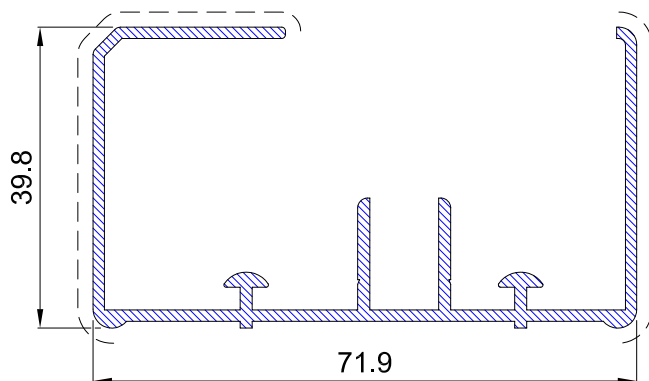

Marco inferior

Ref.: 12792

Peso (kg/m): 0.913

Momentos de inercia

Perímetro (mm): 439

Ix (cm4): 6,14

Iy (cm4): 21,98

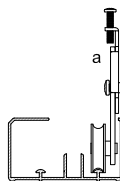

Accesorios

Montaje

a: A497459B  
(GA-257)

Manual

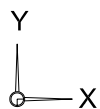



Several

Varios

12791

73 x 42 mm lower frame cover

Tapa marco inferior de 73 x 42 mm

Ref.: 12791

Peso (kg/m): 0.427

Momentos de inercia

Perímetro (mm): 212

Ix (cm4): 1,90

Iy (cm4): 0,91

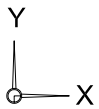
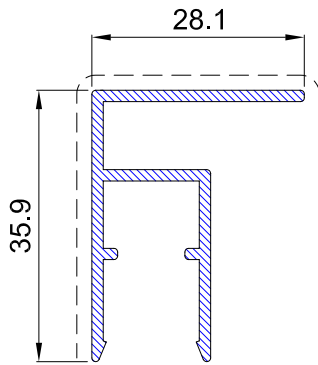

3837

Upper frame

Marco superior

Ref.: 3837

Peso (kg/m): 0.664

Momentos de inercia

Perímetro (mm): 343

Ix (cm4): 3,10

Iy (cm4): 16,87

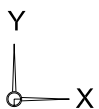
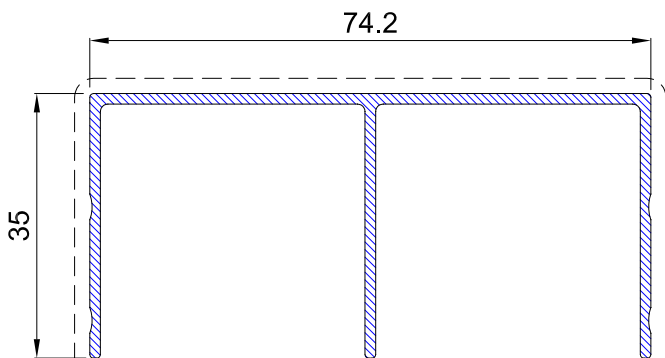

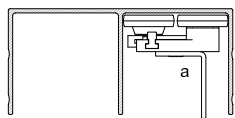
	Accesorios	Montaje
	a: A497457B (GA-209)	Manual



# SERIE MAMPARAS

Perfiles mamparas

Screen profiles

2133

60.8 x 33 mm double screen mounting

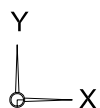
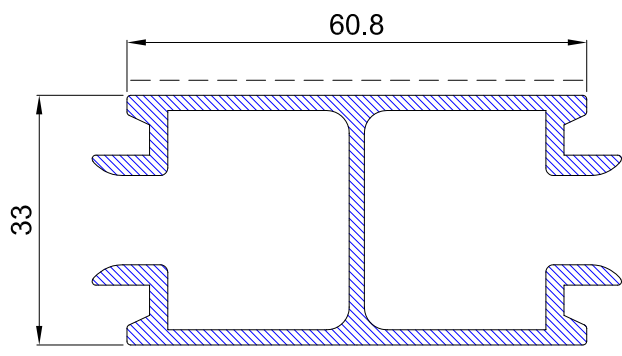

Travesaño mampara doble de 60.8 x 33 mm

Ref.: 2133

Peso (kg/m): 1.296

Momentos de inercia

Perímetro (mm): 419

Ix (cm4): 7,97

Iy (cm4): 21,13

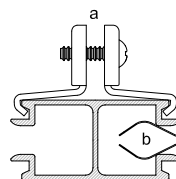

Accesorios

Montaje

a: A497524B

Manual

b: A497523B

Manual

2134

32.7 x 5.4 mm double screen beading

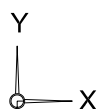
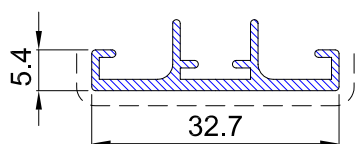

Junquillo mampara de 32.7 x 5.4 mm

Ref.: 2134

Peso (kg/m): 0.232

Momentos de inercia

Perímetro (mm): 132

Ix (cm4): 0,04

Iy (cm4): 0,80

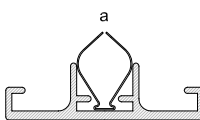

Accesorios

Montaje

a: A497523B

Manual

Screens

Mamparas

2199

49 x 29 mm one sided screen

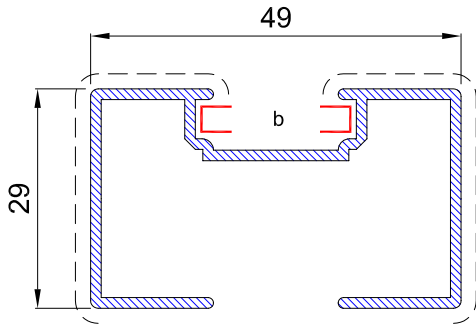

Mampara una cara de 49 x 29 mm

Ref.: 2199

Peso (kg/m): 0.578

Momentos de inercia

Perímetro (mm): 307

Ix (cm4): 2,35

Iy (cm4): 7,09

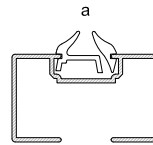

Accesorios

Montaje

a: A497502B  
(3461)

Maquina / Manual

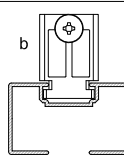

b: A497396B  
(MHC)

Manual

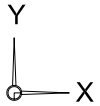

2200

49 x 29 mm two sided screen

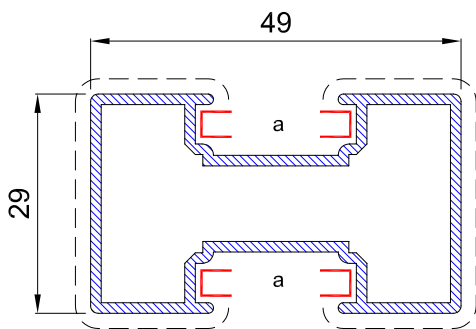

Mampara dos caras de 49 x 29 mm

Ref.: 2200

Peso (kg/m): 0.713

Momentos de inercia

Perímetro (mm): 377

Ix (cm4): 2,71

Iy (cm4): 7,44

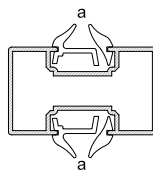

Accesorios

Montaje

a: A497502B  
(3461)

Maquina / Manual

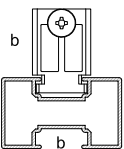

b: A497396B  
(MHC)

Manual

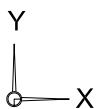

# SERIE MAMPARAS

Mamparas

Screens

3623

49 x 49 mm three sided screen

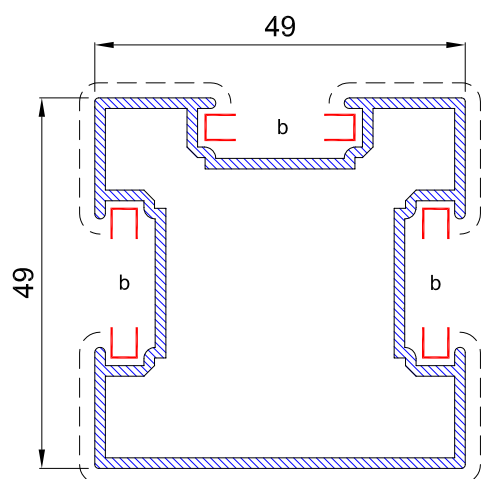

Mampara tres caras de 49 x 49 mm

Ref.: 3623

Peso (kg/m): 0.937

Momentos de inercia

Perímetro (mm): 495

Ix (cm4): 10,82

Iy (cm4): 10,70

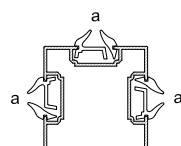

Accesorios

Montaje

a: A497502B  
(3461)

Maquina / Manual

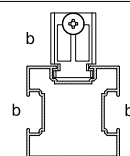

b: A497396B  
(MHC)

Manual

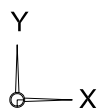

2201

49 x 49 mm four sided screen

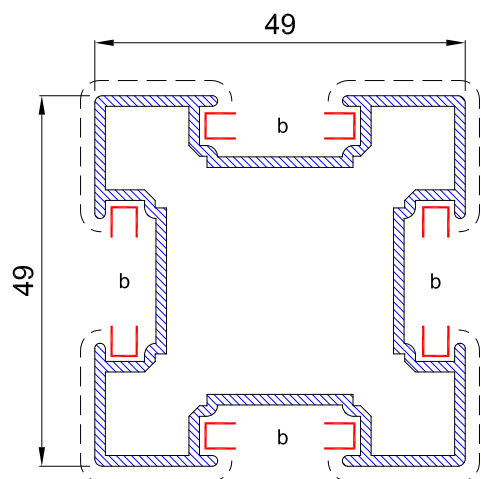

Mampara cuatro caras de 49 x 49 mm

Ref.: 2201

Peso (kg/m): 1.007

Momentos de inercia

Perímetro (mm): 533

Ix (cm4): 0,04

Iy (cm4): 0,80

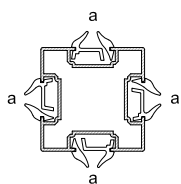

Accesorios

Montaje

a: A497502B  
(3461)

Maquina / Manual

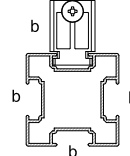

b: A497396B  
(MHC)

Manual

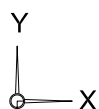

3624

49 x 29 mm angular screen

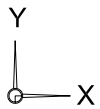
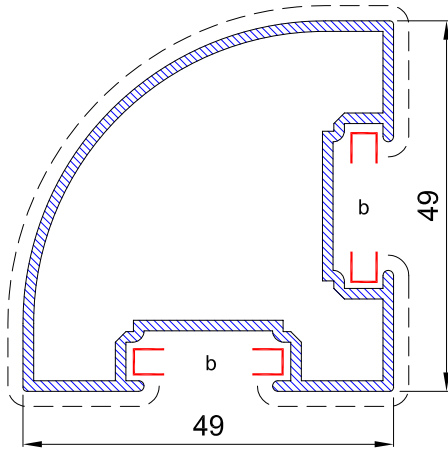

Esquinero mampara de 49 x 29 mm

Ref.: 3624

Peso (kg/m): 0.802

Momentos de inercia

Perímetro (mm): 424

Ix (cm4): 8,32

Iy (cm4): 8,32

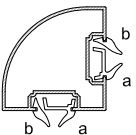
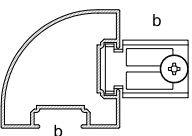
	Accesorios	Montaje
	a: A497502B (3461)	Maquina / Manual
	b: A497396B (MHC)	Manual



# SERIE MAMPARAS

## Perfiles mamparas

## Screen profiles

2202

40 x 27 mm door frame

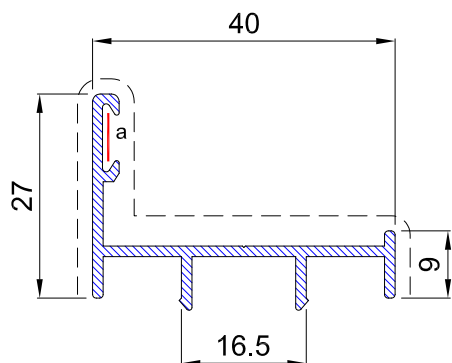

Marco puerta de 40 x 27 mm

Ref.: 2202

Peso (kg/m): 0.367

Momentos de inercia

Perímetro (mm): 196

Ix (cm4): 0,59

Iy (cm4): 2,48

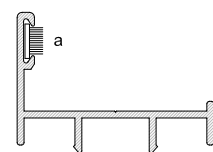

Accesorios

Montaje

a: Polipelo 6.9 x 5



Maquina / Manual

2204

34.1 x 16 mm lower glass cabinet frame

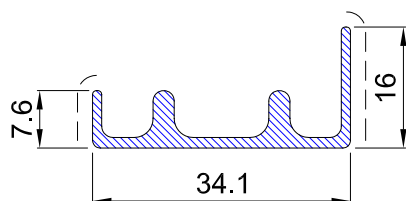

Marco inferior vitrina de 34.1 x 16 mm

Ref.: 2204

Peso (kg/m): 0.308

Momentos de inercia

Perímetro (mm): 131

Ix (cm4): 0,13

Iy (cm4): 1,35

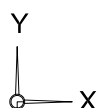

2205

34.1 x 16 mm lateral glass cabinet frame

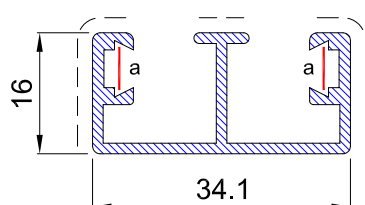

Marco lateral vitrina de 34.1 x 16 mm

Ref.: 2205

Peso (kg/m): 0.402

Momentos de inercia

Perímetro (mm): 207

Ix (cm4): 0,46

Iy (cm4): 2,12

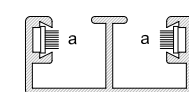

Accesorios

Montaje

a: Polipelo 6.9 x 5



Maquina / Manual

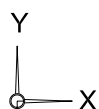

Screen profiles

Perfiles mamparas

2203

33 x 11.7 mm sliding roulette sash

Hoja ruleta corredera de 33 x 11.7 mm

Ref.: 2203

Peso (kg/m): 0.305

Momentos de inercia

Perímetro (mm): 158

Ix (cm4): 0,26

Iy (cm4): 0,94

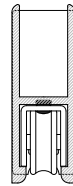
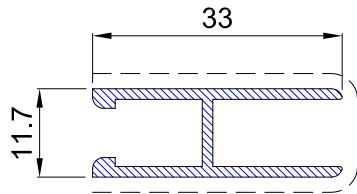

Accesorios

Montaje

b: A497579B  
(2510)

Manual

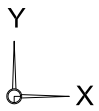

a

2567

81.3 x 56 mm double screen base

Cazoleta mampara doble de 81.3 x 56 mm

Ref.: 2567

Peso (kg/m): 0.894

Momentos de inercia

Perímetro (mm): 439

Ix (cm4): 12,89

Iy (cm4): 27,61

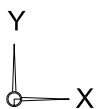
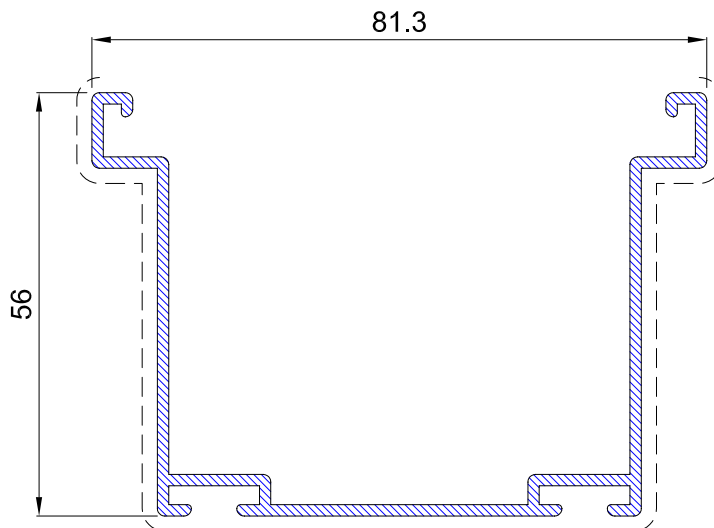

SECCIÓN D-D

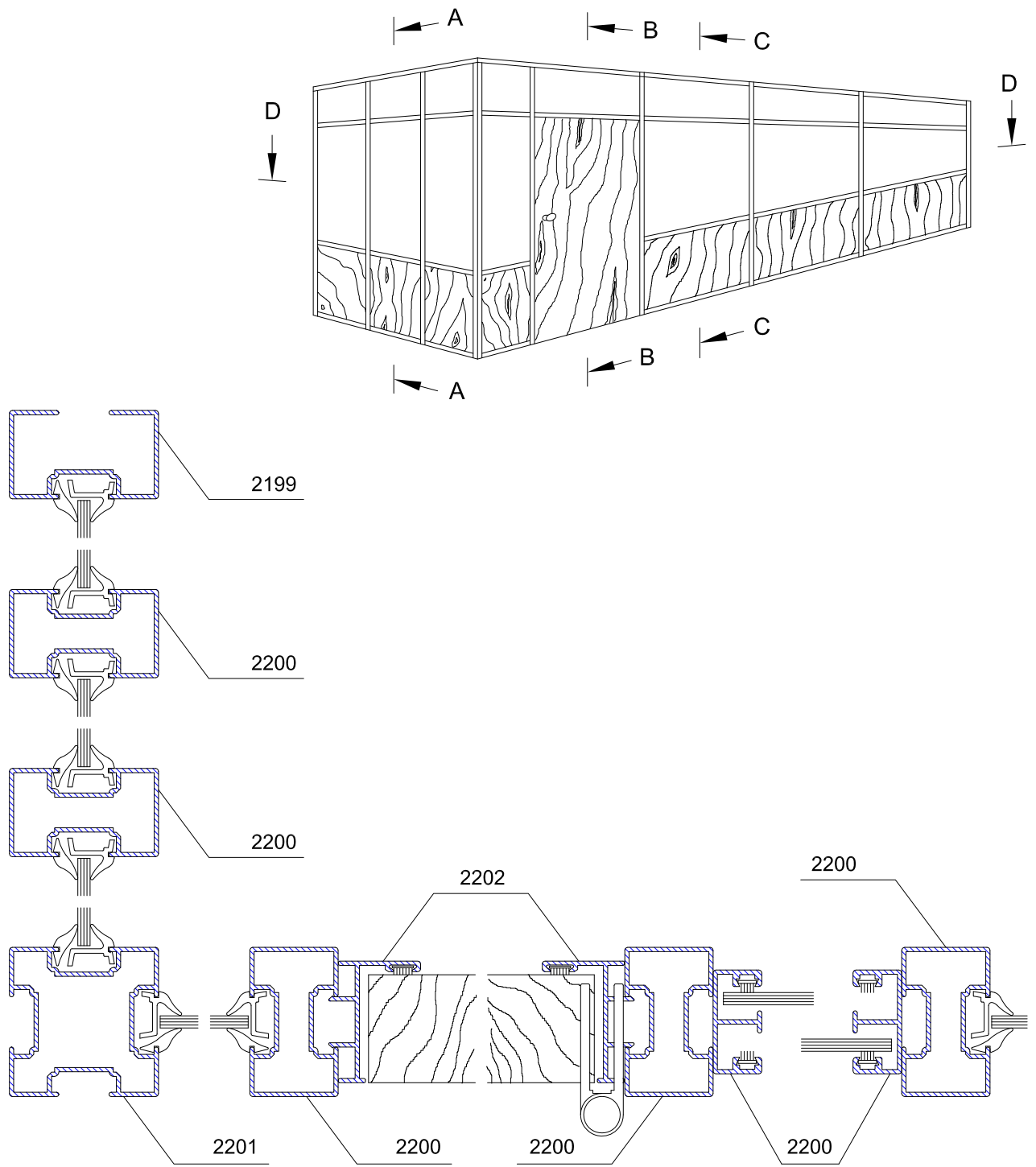



SECCIÓN A-A

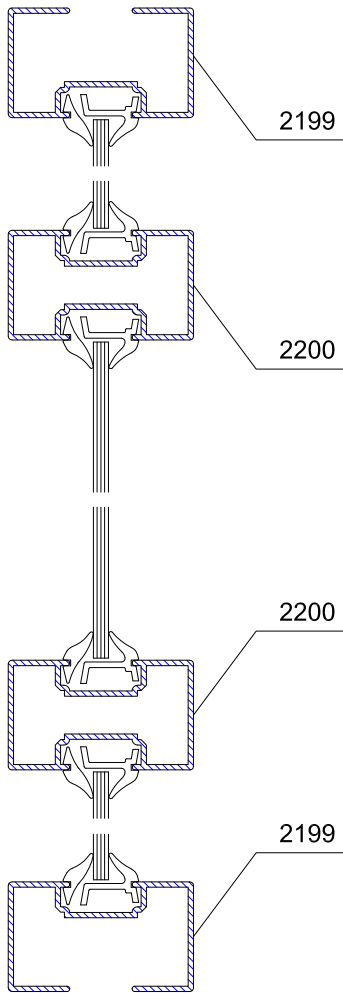

SECCIÓN B-B

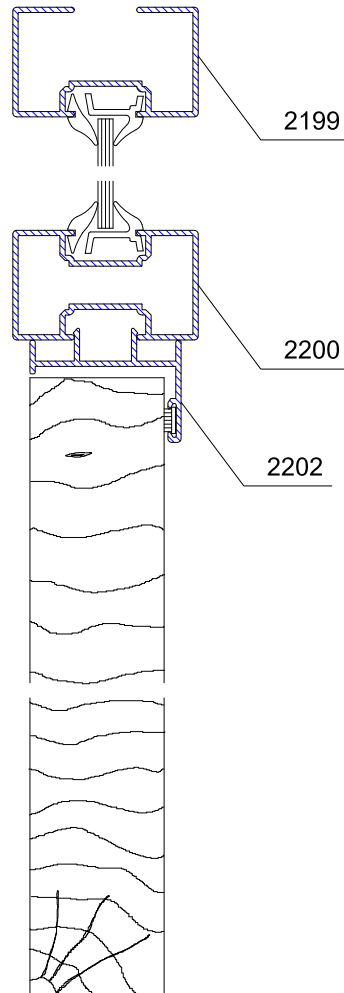



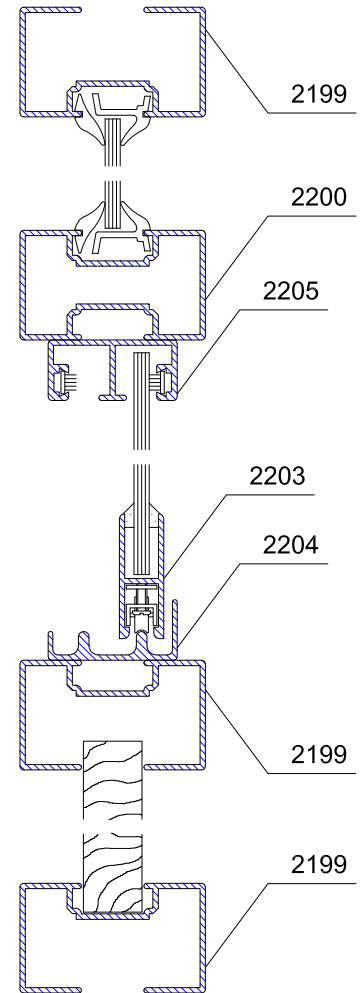



SECCIÓN C-C

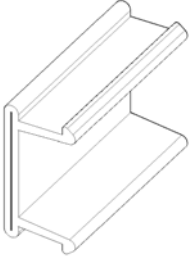

# SERIE MUEBLES

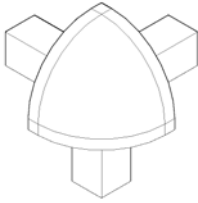

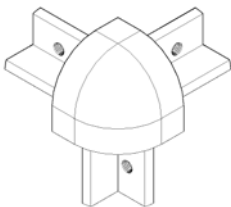
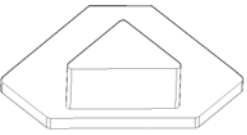
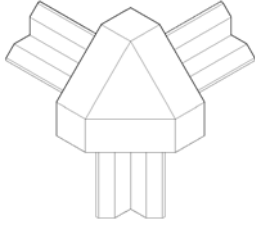
## Accesorios

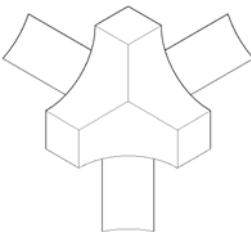
## Hardware

Codigo Code	Descripción y características Description and properties	Codigo Code	Descripción y características Description and properties
	<p><b>A497400B</b> Tapacanal adin (3441) Lidcanal adin</p>		<p><b>A497537B</b> Tapeta perfil octogonal L-8 (3818) Octogonal profile flap L-8</p>
	<p><b>A497536B</b> Tapeta mueble mc-40 (815) Furniture flap mc-40</p>		<p><b>A497089B</b> Nudo zamak mc-40 (3505) Zamak knot mc-40</p>
	<p><b>A497413B</b> Tapeta mueble mc-30 (3811) Furniture flap mc-30</p>		<p><b>A497401B</b> Nudo zamak mc-30 (3501) Zamak knot mc-30</p>
	<p>Tapeta mueble t-30 Furniture flap t-30</p>		<p>Nudo zamak t-30 Zamak knot t-30</p>
	<p>Tapeta mueble cm-30 Furniture flap mc-40</p>		<p>Nudo zamak cm-30 Zamak knot cm-30</p>

Hardware

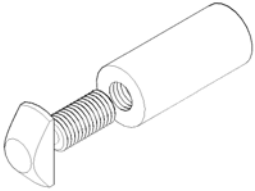
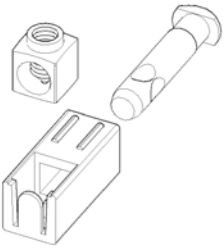
Accesorios

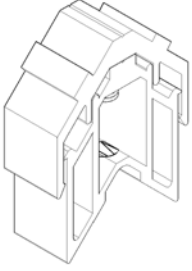

Codigo Code	Descripción y características Description and properties	Codigo Code	Descripción y características Description and properties
	<p><b>A497423B</b> Portaestantes de latón (3911) Shelvesport of bras</p>		<p><b>A497424B</b> Tensor o grapas (3 piezas) (3711) Tensor or staples (3 pieces)</p>
	<p><b>A497665B</b> Escuadra cuadros 30mm redondos 30 mm rounds cleat of pictures</p>		<p><b>A497664B</b> Escuadra cuadros con tornillos Cleat of pictures with screws</p>
	<p><b>A497857B</b> Escuadra inox arm (00-1731-50) Inox cleat</p>		



# SERIE MAMPARAS

## Accesorios

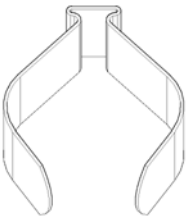
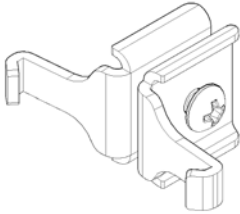
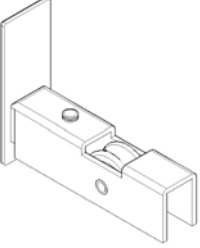
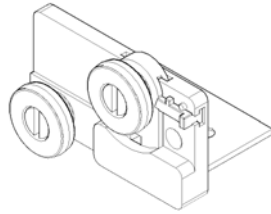
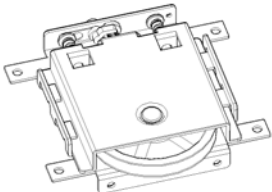
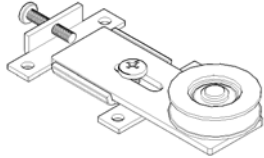
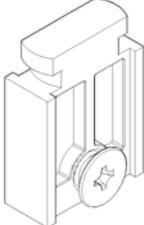
## Hardware

Codigo Code	Descripción y características Description and properties	Codigo Code	Descripción y características Description and properties
	<p><b>A497523B</b> Pinzas mampara Screen clamps</p>		<p><b>A497524B</b> Ataque de mampara Attack of screen</p>
	<p><b>A497579B</b> Ruleta de vitrina (2510) Roulette glass cabinet</p>		<p><b>A497457B</b> Rueda superior armario (GA-209) Upper rouller wardrobe</p>
	<p><b>A497458B</b> Rueda inferior carril bajo (GA-256) Lower rouller rail under</p>		<p><b>A497459B</b> Rueda inferior marco alto (GA-257) Lower rouller frame high</p>
	<p><b>A497396B</b> Tensor mampara + tornillos (MHC) Tensor scren + screws</p>		<p><b>A497502B</b> Juego goma acristalamiento (3461) Game glass gasket</p>





**FÁBRICA Y OFICINAS:**  
**FACTORY AND**  
**HEADQUARTERS:**  
 Lugar Campaña, s/n,  
 CP. 36645 VALGA  
 (Pontevedra) ESPAÑA  
 Telf.: 902 457 250  
 Fax: 986 557 174  
[comercial@extrugasa.com](mailto:comercial@extrugasa.com)

## Delegaciones

### A CORUÑA

Lugar Sigras, s/n  
 CP. 15181 Cambre  
 Telf.: 981 675 726  
 Fax: 981 676 425  
[almcambre@extrugasa.com](mailto:almcambre@extrugasa.com)

### LUGO

Pol. Ind. Louzaneta s/n  
 CP: 27000 Arieiras  
 Telf.: 982 250 514  
 Fax: 982 250 610  
[almlugo@extrugasa.com](mailto:almlugo@extrugasa.com)

### ORENSE

Pol. Ind. S. Ciprián de Viñas C/9,nº15  
 CP. 32001 San Ciprián de Viñas  
 Telf.: 988 256 665  
 Fax: 988 256 821  
[almoreense@extrugasa.com](mailto:almoreense@extrugasa.com)

### VIGO

Camino del Romeu, 8  
 CP. 36001 Corujo  
 Telf.: 986 237 337  
 Fax: 986 237 336  
[almvigo@extrugasa.com](mailto:almvigo@extrugasa.com)

### OVIEDO

Pol. Ind. de la Roza, naver D  
 CP. 33420 Granda-Siero  
 Telf.: 985 985 350  
 Fax: 985 985 412  
[almasturias@extrugasa.com](mailto:almasturias@extrugasa.com)

### PONFERRADA

Pol. Ind. Camponaraya, Sect.1, N.12  
 CP. 24000 Camponaraya  
 Telf.: 987 463 277  
 Fax: 987 450 404  
[almponferrada@extrugasa.com](mailto:almponferrada@extrugasa.com)

### PALENCIA

Pol. Ind. de Villamuriel, Parc. 3 y 4  
 CP. 34190 Villamuriel  
 Telf.: 979 761 042  
 Fax: 979 761 043  
[almpalencia@extrugasa.com](mailto:almpalencia@extrugasa.com)

### SALAMANCA

Pol. Ind. Montalvo, C/Novel, Parc. 101  
 CP. 37008 Salamanca  
 Telf.: 923 190 428  
 Fax: 923 190 556  
[almsalamanca@extrugasa.com](mailto:almsalamanca@extrugasa.com)

### GERONA

Pol. Ind. S. Feliu de Buixalleu, S. II, N 7  
 CP. 17451 Hostalric  
 Telf.: 972 865 204  
 Fax: 972 865 482  
[almcatalunya@extrugasa.com](mailto:almcatalunya@extrugasa.com)

# Extrugasa

Extrusión, Lacado, Anodizado y Mecanizado

de Perfiles de Aluminio.

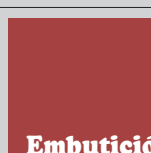
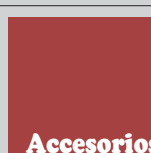
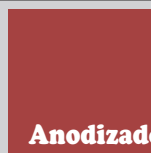
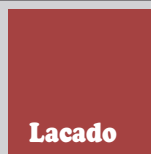
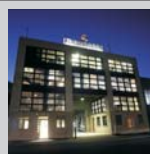
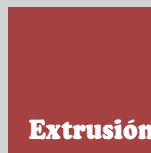
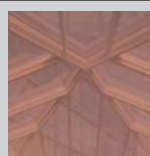
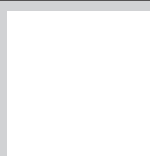

[www.extrugasa.com](http://www.extrugasa.com)

